

Frascio®

T600/T700 Series Tubular Latchsets

Beautiful world class designs and proven performance, ideal for your residential or hospitality project.

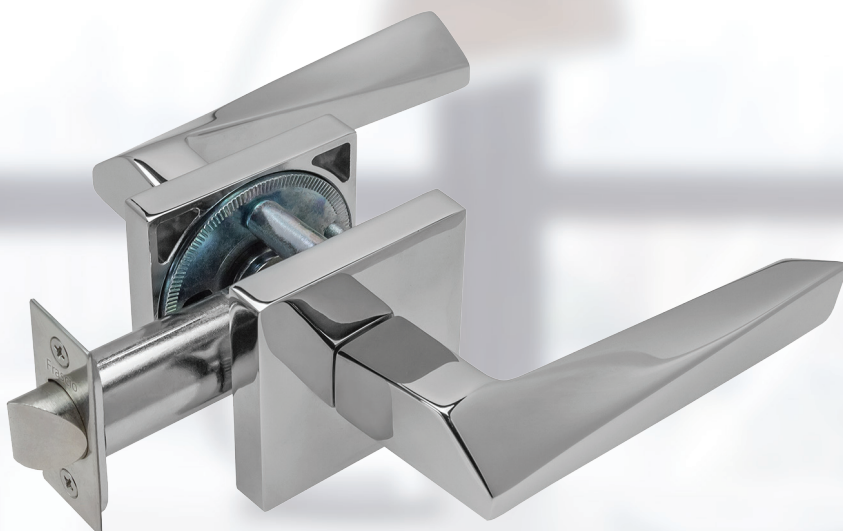

A valued brand of

FR International

www.FRInternational.com

About Us

From our earliest beginnings in 1945 as a workshop in northern Italy, Frascio has grown to become a globally recognized decorative door hardware brand specified by premier architects and designers worldwide.

We remain true to our original manufacturing philosophy: to use only the highest quality materials, to continuously research emerging designs and technology, and to uphold careful attention to production detail.

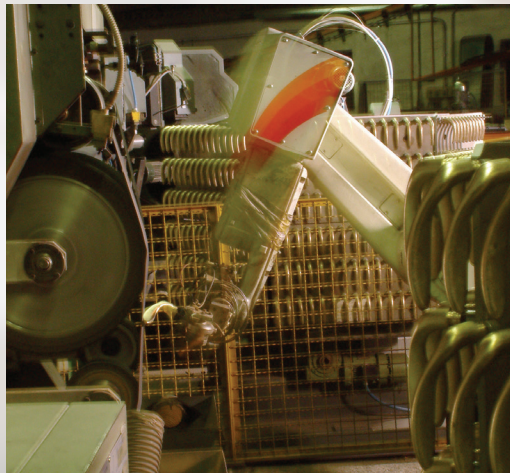
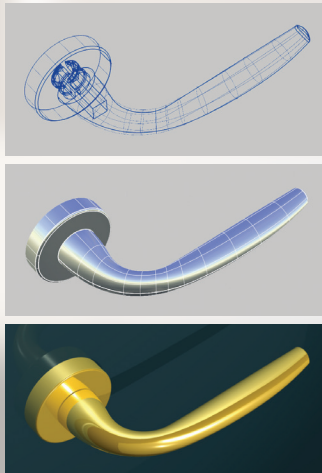

We utilize the latest CAD engineering tools to create designs and ensure reliable system operation. And, for those projects that require additional shapes and configurations, we are pleased to offer our custom design services.

FR International, based in Carmel, Indiana, provides the commercial marketplace with all the advantages of a high-end decorative hardware brand combined with strong mechanical engineering and commercial hardware industry experience. Our designs are available on rugged commercial quality mechanical platforms that conform to market requirements.

Find our full downloadable Frascio Design Catalog online at FRInternational.com or contact us for physical electronic media version.



Environmentally-friendly manufacturing

Frascio products are manufactured primarily from brass, zinc, stainless steel, and steel. Much of the raw material used to produce these parts comes from recycled metal. The percentage of postconsumer and post-industrial recycled content is estimated as follows:

- ♻️ The brass and zinc materials that are used to make many Frascio products typically contain 80-100% recycled material, a combination of melted scrap metal and reclaimed by-products.
- ♻️ The post-industrial recycled content of steel used to make Frascio products is approximately 30-40% (Approximately 30%-40% of the metal used to produce Frascio products is either scrap metal or other recycled material that is melted in the furnace)
- ♻️ Stainless steel that is used in Frascio products has a post-industrial recycled content of approximately 70%, and a post-consumer recycled content of approximately 8%.
- ♻️ Approximately 40% of the packaging that is used by Frascio is comprised of recycled material

The above percentages show an average of Frascio's overall production. Actual percentages on any order will vary based on the specific products that comprise that order as well as the mill source.

When no longer needed, Frascio brass, stainless, and zinc parts are 100% recyclable.

Frascio is committed to responsible business and manufacturing practices that help conserve resources and protect our environment.

Frascio T600 and T700 Series tubular latchsets provide the ideal decorative hardware solution for interior doors in residential and hospitality applications.

BOTH PLATFORMS OFFER:

- ▶ Full interchangeability of rose design options within each series.
- ▶ Contemporary style that flows seamlessly throughout the facility.
- ▶ Wide variety of compelling lever designs from our world-renowned studio.
- ▶ Tubular leversets are reversible and do not require handing
- ▶ Fast, easy installation
- ▶ Concealed trim fasteners
- ▶ Perfect complement to matching mortise lock and access control trim, as well as exit device adaptation
- ▶ Matching accessories available include door stops, sliding door locks and trim, door pulls, and more

Design updates have never been easier

When it's time to update or redesign, our exclusive modular product platform is designed to make it easy to update to new trim styles or finishes. Simply remove the lever and rose trim and replace them with a new style without the need to remove or replace the mechanical operating system.

This environmentally-friendly system is easy and saves you time and money.

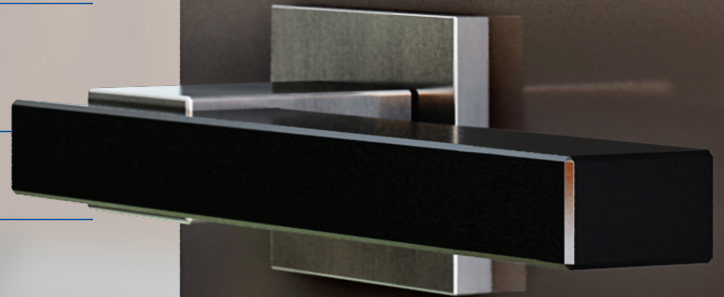

T600 Tubular Latchset

for 2-1/8" Bored-Hole Application



Frascio's T600 latchset is designed for maximum reliability, use with standard door prep, and easy time-saving installation — a proven favorite of designers everywhere.

A beautiful lever trim set needs a mechanical system that allows it to perform flawlessly for years. Frascio's T600 tubular lever sets deliver outstanding performance every time due to its unique heavy duty interlocking backplate system.

Superior features and benefits of our T600 interlocking backplate

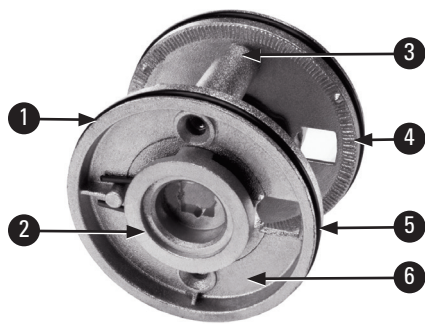

- 1 **Cast-in latch stabilizing legs** connect with latch body to provide stability
- 2 **Solid spring-loaded hubs** provide excellent lever support
- 3 **Interlocking legs** allow easy self-guiding throughbolt installation
- 4 **Cast in grip texture** provides tight surface grip and resists rotation
- 5 **Durable rubber o-ring** attaches securely to large format roses
- 6 **Solid cast body** provides sturdy mounting for roses

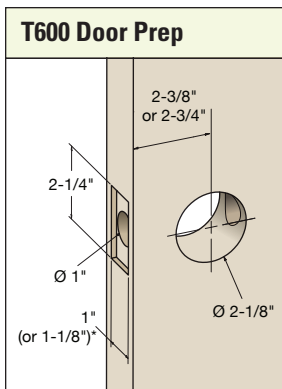

Dimensions are approximate and for reference only. Please refer to Frascio template.



T600 Specifications	
Application	Residential and hospitality interior doors requiring passage, privacy, communicating, and dummy trim functions
Material	Brass, stainless steel, and die cast zinc levers and roses. Latch faceplates and strikes stainless steel
Backset	2-3/8" (60mm) and 2-3/4" (70mm)
Handing	Non-handed trim set. Latchbolt handing and bevel is field reversible
Door Thickness Range	1-3/8" (35mm) to 2" (51mm); thick door parts kit available
Door Preparation	2-1/8" Bored Hole — refer to door prep template for specifics. ANSI 160 or ANSI 161
Faceplate	1" x 2-1/4" square corner standard; 1-1/8" wide option available
Strike	1-1/8" x 2-3/4" T Strike with 1-1/8" lip standard; Full Lip Strike, 1/4" Radius Full Lip Strike and ASA Strike options available

Complies with ANSI Grade 2 cycle testing requirements.

T600 Series Rose Options — Fully interchangeable within the T600 Series



1903 Contemporary Rose
65 mm (2-9/16")



1905 Traditional Rose
63 mm (2-1/2")



1912 Smooth Rose
63 mm (2-1/2")

1912-76 Smooth Retrofit Rose
76 mm (3")
Larger size to cover previous oversized door preps



1912Q Square Rose
65 mm (2-9/16")



1912QE Rectangular Extended Rose
65 mm (2-9/16") x 102 mm (4")

T600 Function Chart

Function Code Number	Illustration Outside ◀ ▶ Inside	Function/Description	ANSI Number
PA		Passage Latchbolt retracted by lever from either side at all times	F75
PY		Privacy Latchbolt retracted by lever from either side, unless outside is locked by inside pushbutton. Turning inside lever or closing door unlocks outside lever. To unlock from outside, insert emergency tool into privacy access hole in rose.	F76A
CPABP		Communicating Passage for Blind Prep (no plate) Latchbolt retracted by inside lever. No trim or cover plate on outside.	F111
CPACP		Communicating Passage with Cover Plate Latchbolt retracted by inside lever. Blank cover plate on outside.	F111
SD (SD-TB)		Single Dummy Surface mounted Single Dummy Through bolt mounted to back side	
FD (FD-TB)		Full Dummy Surface mounted Full Dummy Through bolt mounted	

T600 tubular leverset ordering example:

Sweep lever on a 1912Q standard square rose, passage function, in polished chrome finish, 2-3/4" backset

720	1912Q	PA	625	2-3/4	1SC	TSTK1	
Lever design	Rose/Plate	Function	Finish	Backset	Latch	Strike	Misc.
Sweep 720	1912 (65 mm) 1903 (65 mm) 1905 (65 mm) 1912Q (65 mm) 1912-76 (76 mm)	PA (Passage) PY (Privacy) FD (Full Dummy) SD (Single Dummy)	Per project specification	2-3/8" 2-3/4"	1SC Standard Commercial Latch (L701)	TSTK1 Standard T-Strike	

T700 Tubular Latchset

for Custom Small Bored-Hole Application



The Frascio T700 is an innovative small rose trim solution matching the tubular latchsets' appearance with mortise locks — when elegance and continuity matter.

T700 lever sets provide the optimal combination of elegant aesthetics and outstanding commercial-grade performance. The T700 utilizes the same rose mounting backplate system and rose platform as we use for ANSI Grade 1 mortise trim. Unparalleled mechanical performance and virtually unlimited decorative design option capability are sure to please.

Superior features and benefits of our innovative T700 mounting backplate

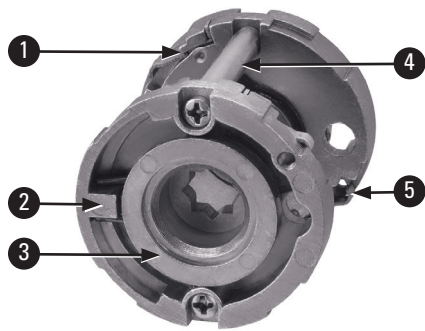

- 1 **Innovative rose mounting system** securely attaches rose to door. Exceeds ANSI Grade 1 axial pull resistance (Provides secure side option if desired)
- 2 **Solid cast body** provides sturdy mounting for a variety of rose shapes and sizes in the series
- 3 **Solid spring-loaded spindle hubs** provide excellent lever support
- 4 **Durable steel throughbolt post system** provides commercial strength as well as flexibility for door thickness variation
- 5 **Innovative concealed fastener system** eliminates need for multi-piece roses and posts that can be removed or tampered with

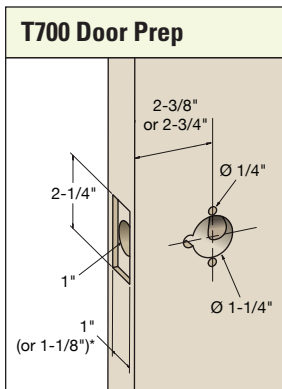

Dimensions are approximate and for reference only. Please refer to Frascio templates.



T700 Specifications	
Application	Residential and hospitality interior doors requiring passage, privacy, communicating, and dummy trim functions
Material	Brass, stainless steel, and die cast zinc levers and roses. Latch faceplates and strikes stainless steel
Backset	2-3/8" (60mm) and 2-3/4" (70mm)
Handing	Non-handed trim set. Latchbolt handing and bevel is field reversible
Door Thickness Range	1-3/8" (35mm) to 2" (51mm); thick door parts kit available
Door Preparation	Custom small hole door drilling required — refer to door prep templates for specifics
Faceplate	1" x 2-1/4" square corner standard; 1-1/8" wide option available
Strike	1-1/8" x 2-3/4" T Strike with 1-1/8" lip standard; Full Lip Strike, 1/4" Radius Full Lip Strike and ASA Strike options available

Complies with ANSI Grade 2 cycle testing requirements.

T700 Series Rose Options — Fully interchangeable within the T700 Series



SMT Small Traditional Rose
58 mm (2-1/4")



SM Small Rose
52 mm (2")
SM-58 Small Retrofit Rose
58 mm (2-1/4")



SMQ Small Square Rose
54 mm (2")



SMQR Small Radiused Square Rose
54 mm (2")

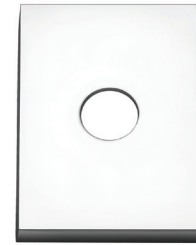

SMQE Small Rectangular Rose
54 mm (2-1/8") x
77 mm (3")

T700 Function Chart

Function Code Number	Illustration Outside ◀ ▶ Inside	Function/Description	ANSI Number
PA		Passage Latchbolt retracted by lever from either side at all times	F75
PY		Privacy Latchbolt retracted by lever from either side, unless outside is locked by inside pushbutton. Turning inside lever or closing door unlocks outside lever. To unlock from outside, insert emergency tool into privacy access hole in rose.	F76A
CPABP		Communicating Passage for Blind Prep (no plate) Latchbolt retracted by inside lever. No trim or cover plate on outside.	F111
CPACP		Communicating Passage with Cover Plate Latchbolt retracted by inside lever. Blank cover plate on outside.	F111
SD (SD-TB)		Single Dummy Surface mounted Single Dummy Through bolt mounted to back side	
FD (FD-TB)		Full Dummy Surface mounted Full Dummy Through bolt mounted	

T700 tubular leverset ordering example:

Kuma lever on a small rose, passage function, in brushed satin chrome finish, 2-3/4" backset

Lever design	Rose/Plate	Function	Finish	Backset	Latch	Strike	Misc.
640	SM	PA	626	2-3/4	1SC	TSTK1	
Kuma 640	SM (52 mm) SMT (58 mm) SMO (60 mm) SMQ (54 mm) SMQR (54 mm)	PA (Passage) PY (Privacy) FD (Full Dummy) SD (Single Dummy)	Per project specification	2-3/8" 2-3/4"	1SC Standard Commercial Latch (L701)	TSTK1 Standard T-Strike	

Latch and Strike Options

Frascio offers a variety of tubular latch and strike options, available for use on both the T600 Series standard bore and T700 Series small bore latchsets.

Standard Frascio passage and privacy spring latches

- Durable cast latch housing
- Solid brass latch bolt
- Non-handed
- Exceed cycle test requirements for Grade 2 certification
- Available in 2-3/8" (60mm) and 2-3/4" (70mm) backsets

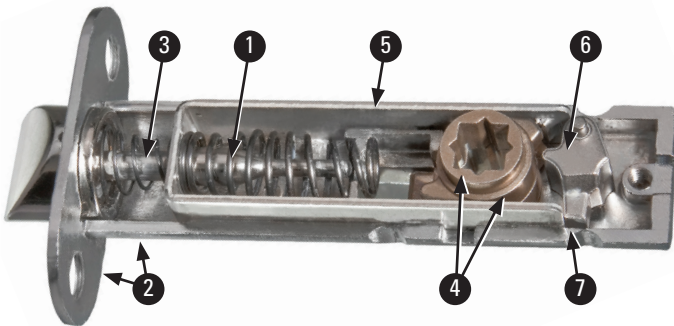

- 1 Heavy-duty springs** provide robust strength and prevent lever sag
- 2 1-piece cast latch case and mounting flange** provides superior strength, stability, and durability
- 3 Stainless steel plunger** shoulder rod cannot come disengaged from retractor
- 4 Separate stainless steel lever hubs** allows independent operation of interior and exterior sides
- 5 Stainless steel retractor** ensures smooth, reliable operation
- 6 Stainless steel cam follower** creates positive stop for retractor and hubs
- 7 Integrated interlocking design** casting design connects with Frascio Interlocking Backplate to provide exceptional stability and resistance to operating torque

Strike options

TSTK1

T-Strike (standard)*

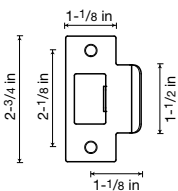

TSTK2

Full Lip, 1/4" Radius Corner Strike

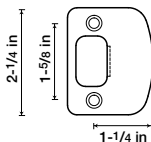

TSTK3

ANSI Prep Strike

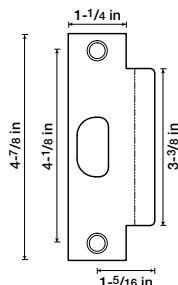

TSTK4

Full Lip Square Corner Strike

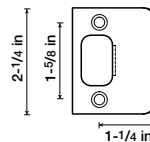

*Latches are automatically provided with TSTK1 T-strike and strike box, unless otherwise specified.

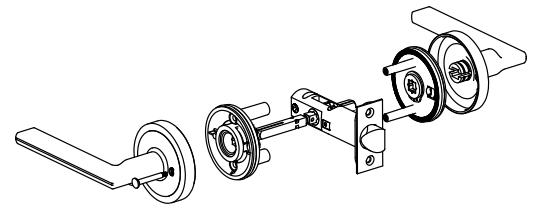

1SC Series Latch (Commercial Grade)

Ideal for hospitality/light commercial
Heavy duty performance, 28° retraction

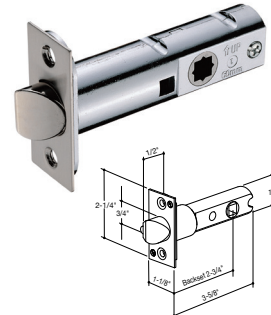

HL Series Latch (Medium Grade)

Ideal for multi-family/condominiums
Durable performance, 28° retraction

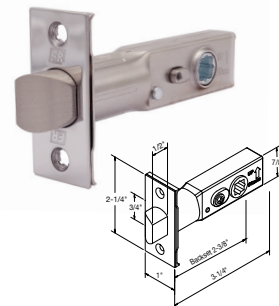

RL Series (Residential Grade)

Ideal for multi-family/apartments
Standard duty, value driven

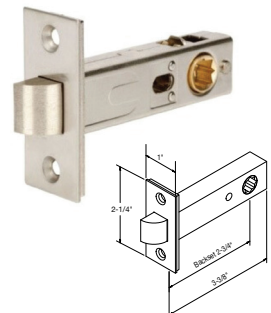

Line art dimensions are approximate and for reference purposes only.

Levers

Choose from hundreds of high-end decorative lever designs engineered using the highest quality materials and crafted with careful attention to detail.

Many more designs are available in our product catalog at www.FRIInternational.com.



110 Apollo



146 Star



200 Easy



220 Alpha

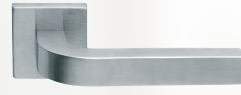

230 Beta



250 Butterfly



270 Metro



280 Straight



290 Kube



300 Laguna



380 Julius



400 Soft



401 Soft Plus



610 Pinax



620 Tuke



630 Eidos



640 Kuma



650 Kalé



700 Flow



710 Aria

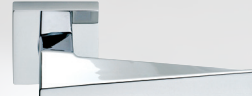

720 Sweep



745 Modulo L



785 Bambu



813 Verano



823 Saló



900 Stella



903 Trevi



937 Corina



939 Allegra



1023 Ursa



1200 Bump



1210 Filoo



1220 Anatra



1540 Chill



1550 Chill+



2250 Halley



5000 Alessia



5013 Urbano

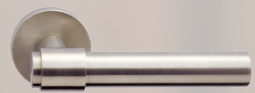

5019 Band



5100 Lucia



5130 Delta



5150 Gamma



5200 Loft

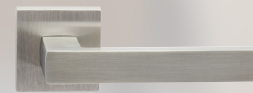

5219 Misano



5300 Omega



5350 Raffaella



5550 Laura



5650 Gabriella



5700 Loredana



5702 Stefano



5750 Adina



5752 Ellise



5800 Antonella



5804 Maretto



5820 Forino



5850 Christina



5855 Sophia



6118 Lorenzo



6202 Decora



6208 Esago



6210 Base



6215 Valenza



6218 Simpla

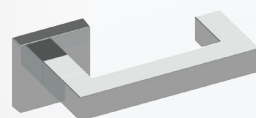

6220 Kappa



6280 Vienna

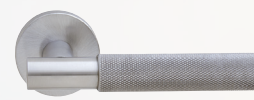

6587 Tacta



6592 Cutlass



6594 Modulo B



6605 Textura



6612 Marco



6774 Scala



6716 Arno

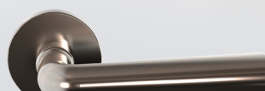

6760 Hathaway



6789 Chamfer



6843 Acton

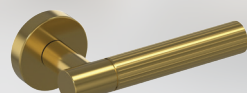

6891 Marino



6902 Bristol

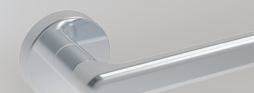

6929 Tivoli



6947 Sutton



6949 Waverly

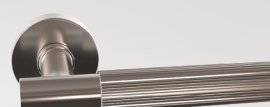

6967 Larissa

View more lever designs
in our product catalog at
www.FRIInternational.com

frascio®

Proudly Celebrating 80 years
of Innovative Hardware Design

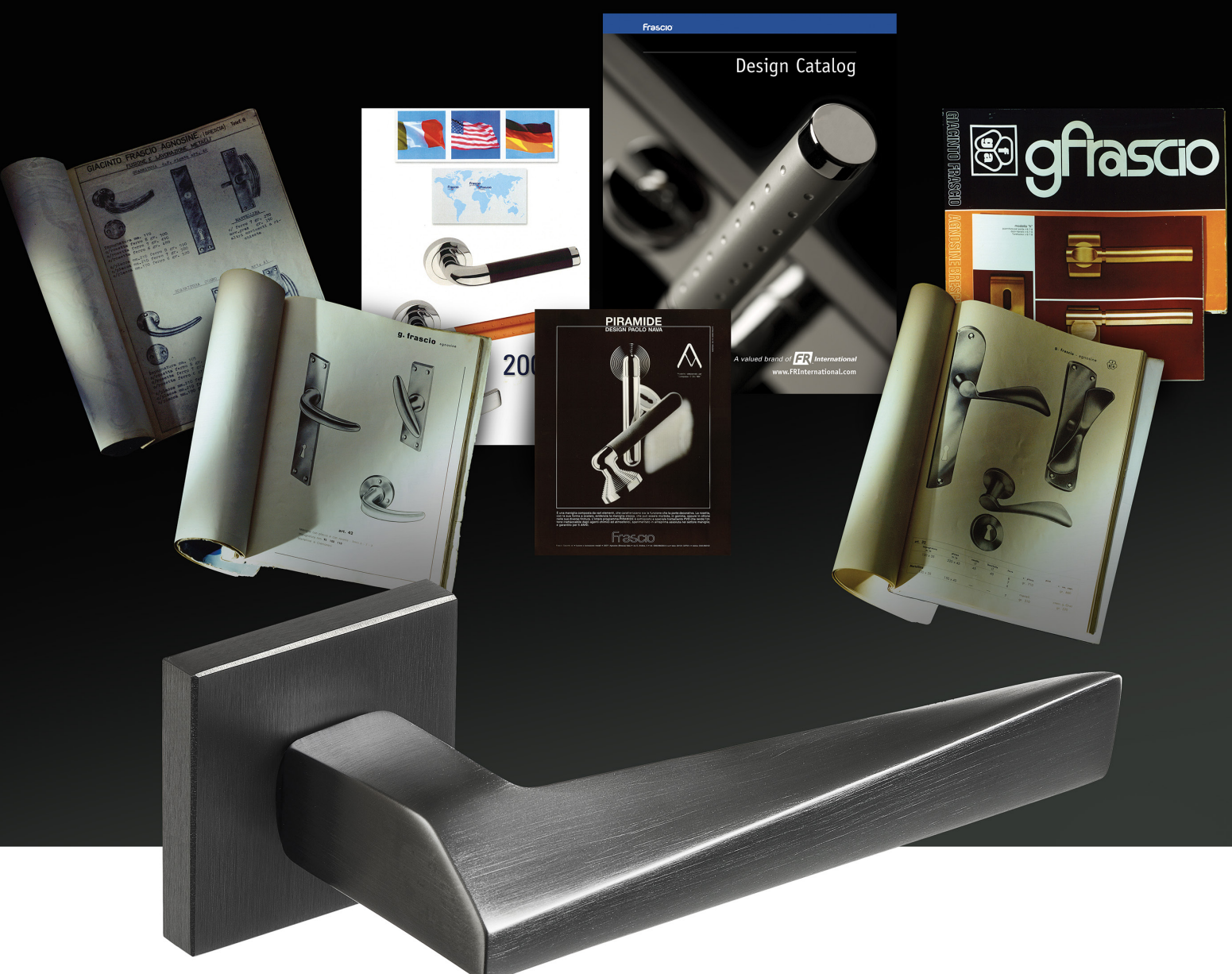

FR International, LLC
1011 3rd Avenue S.W.
Carmel, Indiana USA 46032
Tel: (317) 663-0030
Fax: (317) 663-0029
Toll Free: 1-800-238-9711
www.FRInternational.com



TL0825